

The JBL logo is displayed in white, bold, sans-serif capital letters on a solid orange rectangular background.

HT PS300
Powered
Subwoofer
simple
set-up guide

thank you for choosing JBL. For over 50 years, JBL has been involved in every aspect of musical and film recording and reproduction, from live performances to monitoring the recordings you play in your home, car, or office.

We're confident that the **JBL loudspeaker** you have chosen will provide every note of enjoyment that you expected – and that when you think about purchasing additional audio equipment for your home, car, or office, you will once again choose JBL.

Please take a moment to complete the enclosed profile card. It enables us to keep you posted on our latest advancements, and helps us to better understand our customers and build products that meet your needs and expectations.

JBL Consumer Products

read first! Important Safety Precautions!

CAUTION

**RISK OF ELECTRIC SHOCK
DO NOT OPEN**

CAUTION: To prevent electric shock, do not remove the grounding plug on the power cord, or use any plug or extension cord that does not have a grounding plug provided.

Make certain that the AC outlet is properly grounded. Do not use an adapter plug with this product.



The lightning flash with arrowhead symbol, within an equilateral triangle, is intended to alert the user to the presence of uninsulated "dangerous voltage" within the product's enclosure that may be of sufficient magnitude to constitute a risk of electric shock to persons.



The exclamation point within an equilateral triangle is intended to alert the user to the presence of important operating and maintenance (servicing) instructions in the literature accompanying the appliance.

- 1. Read Instructions.** All the safety and operating instructions should be read before the product is operated.
- 2. Retain Instructions.** The safety and operating instructions should be retained for future reference.
- 3. Heed Warnings.** All warnings on the product and in the operating instructions should be adhered to.
- 4. Follow Instructions.** All operating and use instructions should be followed.
- 5. Water and Moisture.** The product should not be used near water – for example, near a bathtub, washbowl, kitchen sink, laundry tub, in a wet basement, or near a swimming pool, and the like.
- 6. Accessories.** Do not place this product on an unstable cart, stand, tripod, bracket, or table. The product may fall, causing serious injury to a child or adult, and serious damage to the product. Use only with a cart, stand, tripod, bracket, or table recommended by the manufacturer, or sold with the product. Any mounting of the product should follow the manufacturer's instructions, and should use a mounting accessory recommended by the manufacturer.
- 7. Wall or Ceiling Mounting.** The product should be mounted on a wall or ceiling only when and as recommended by the manufacturer.
- 8. Ventilation.** Slots and openings in the cabinet are provided for ventilation and to ensure reliable operation of the product and to protect it from overheating, and these openings must not be blocked or covered. The openings should

never be blocked by placing the product on a bed, sofa, rug, or other similar surface. This product should not be placed in a built-in installation such as a bookcase or rack unless proper ventilation is provided or the manufacturer's instructions have been adhered to.

9. Heat. The product should be situated away from heat sources such as radiators, heat registers, stoves, or other products that produce heat. If placed near an amplifier, check with the manufacturer for applicability.

10. Power Sources. This product should be operated only from the type of power source indicated on the marking label. If you are not sure of the type of power supply to your home, consult your product dealer or local power company. For products intended to operate from battery power, or other sources, refer to the operating instructions.

11. Grounding or Polarization. This product may be equipped with a polarized alternating-current line plug (a plug having one blade wider than the other). This plug will fit into the power outlet only one way. This is a safety feature. If you are unable to insert the plug fully into the outlet, try reversing the plug. If the plug should still fail to fit, contact your electrician to replace your obsolete outlet. Do not defeat the safety purpose of the polarized plug.

12. Power-Cord Protection. Power-supply cords should be routed so that they are not likely to be walked on or pinched by items placed upon or against them, paying particular attention to cords at plugs, convenience receptacles, and the point where they exit from the product.

13. Cleaning. Unplug this product from the wall outlet before cleaning. Do not use liquid cleaners or aerosol cleaners. Use a damp cloth for cleaning.

14. Nonuse Periods. The power cord of the product should be unplugged from the outlet when left unused for long periods of time.

15. Lightning. For added protection for this product during a lightning storm, or when it is left unattended and unused for long periods of time, unplug it from the wall outlet and disconnect the antenna or cable system. This will prevent damage to the product due to lightning and power-line surges.

16. Overloading. Do not overload wall outlets, extension cords, or integral convenience receptacles, as this can result in a risk of fire or electric shock.

17. Object and Liquid Entry. Never push objects of any kind into this product through openings, as they may touch dangerous voltage points or short-out parts that could result in a fire or electric shock. Never spill liquid of any kind on the product.

18. Damage Requiring Service. Unplug this product from the wall outlet and refer servicing to qualified service personnel under the following conditions:

- a. The power-supply cord or the plug has been damaged; or
- b. Objects have fallen onto, or liquid has been spilled into, the product; or
- c. The product has been exposed to rain or water; or
- d. The product does not operate normally when following the operating instructions. Adjust only those controls that are covered by the operating instructions, as an improper adjustment of other controls may result in damage and will often require extensive work by a qualified technician to restore the product to its normal operation; or
- e. The product has been dropped, or the enclosure damaged; or
- f. The product does not appear to operate normally or exhibits a marked change in performance.

19. Attachments. Do not use attachments not recommended by the product manufacturer, as they may cause hazards.

20. Replacement Parts. When replacement parts are required, be sure the service technician has used replacement parts specified by the manufacturer or that have the same characteristics as the original part. Unauthorized substitutions may result in fire, electric shock or other hazards.

21. Safety Check. Upon completion of any service or repairs to this product, ask the service technician to perform safety checks to determine that the product is in proper operating condition.

22. Servicing. Do not attempt to service this product yourself, as opening or removing covers may expose you to dangerous voltage or other hazards. Refer all servicing to qualified service personnel.

one. Speaker Placement

The ideal placement for the HT PS300 is along the wall where the front speakers are installed. Because of the side firing design of the sub-woofer, it is recommended that the woofers be placed in a corner at least six inches away from the side walls. Since the HT PS300 is video-shielded, it may be placed in proximity to a television monitor, if desired.

Front view

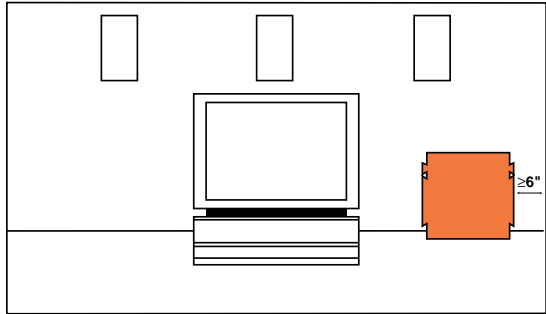

Top view

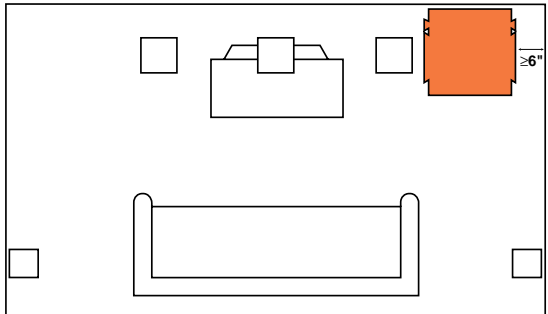

two. Hookup

Line-Level Inputs

THX® Mode:

If your surround processor/receiver is THX certified or contains a subwoofer crossover.

Receiver/Processor

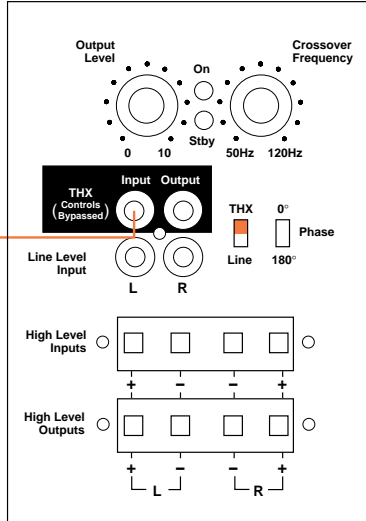
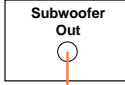

Note: When the THX/Normal switch is set to "THX," the internal crossover and output level control are bypassed.

To continue enjoying THX-quality bass response in a very large room, two or more HT PS300 subwoofers may be connected in series. For every 3000 cu. ft. of room volume, it is recommended that you use one HT PS300.

Receiver/Processor

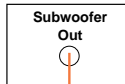

Sub 1

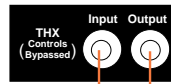

Sub 2

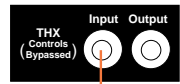

Normal Mode:

If your surround processor/receiver does not contain a subwoofer crossover.

Receiver/Amplifier

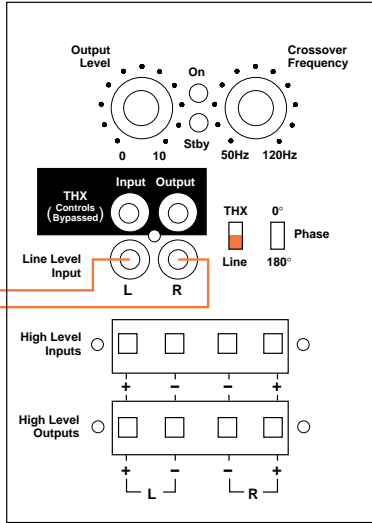
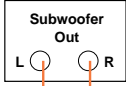

Note: Some receivers/processors have a mono subwoofer output. In this case, you must use a "Y"-connector (not included) in order to maximize the subwoofer's performance.

High Level

If your receiver does not have subwoofer outputs:

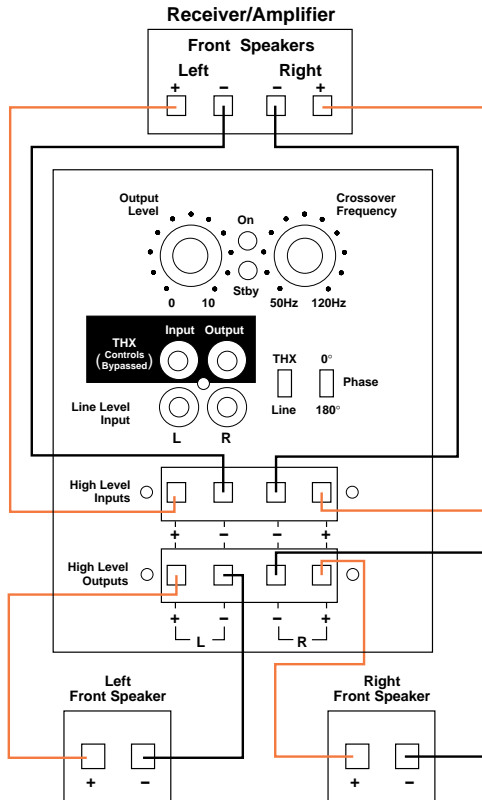

Operation

The HT PS300 contains a signal sensing auto turn-on/off circuit. This feature will automatically turn the

subwoofer on when you turn your system on and begin playing any program material. The subwoofer will return to

standby when no signal is received for approximately 5 minutes. The power switch is for vacation use only.

Mode	Procedure	Standby LED Status	On LED Status
Off	Power switch off	Off	Off
On	Power switch on and play program material	Off	On
Standby	Simply turn off your receiver/processor. The HT PS300 will turn off after approximately five minutes. The subwoofer will turn on when your receiver/processor begins playing again.	On	Off

Output Level

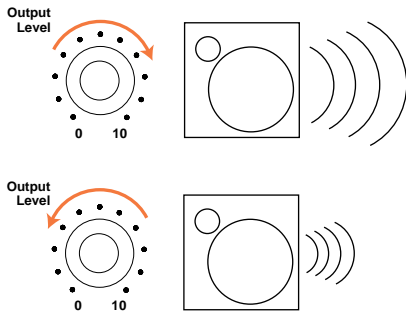

Note: When the THX/Normal switch is set to "THX," the output control is bypassed. Output level is then adjusted at the THX processor.

Crossover Frequency

The Crossover Frequency adjustment determines the highest frequency the HT PS300 will reproduce. It allows a seamless transition from the subwoofer to the

satellite speakers. Experiment with this adjustment to find the crossover frequency that sounds best with your speakers.

Note: When the THX/Normal switch is set to "THX," the internal crossover is bypassed. Crossover frequency is then adjusted at the THX processor.

Phase

The Phase switch is used to adjust the relative polarity of the subwoofer. Listen to your HT PS300 subwoofer and main speakers with the switch in the "0°" position, then listen to the same material with the

switch set to "180°." Decide which sounds better and leave the switch in this position. Repeat this procedure if you change the location of the subwoofer.

Troubleshooting

If there is no output from the subwoofer, check the following:

- System is on and a source is playing.
- The HT PS300 is plugged in and "Power" is on.
- If you are using the THX input, make sure the THX/ Normal switch is set to "THX."
- If you are not using the THX input, make sure the THX/ Normal switch is set to "Normal."
- If you are using the "High Level Inputs," check all wires and connections between the receiver/amplifier and the subwoofer. Make sure all wires are connected and that none of the speaker wires are frayed, cut, or punctured.
- Adjust the "Output Level" control.
- Review proper operation of your receiver/amplifier.

If there is low bass output, check the following:

- Make sure that the subwoofer is plugged into a live electrical outlet and the "Power" is on.
- If you are using the "High Level Inputs," make sure the connections to the left and right "High Level Inputs" have the correct polarity (+ and -).
- Adjust the "Crossover Frequency."
- Adjust the "Output Level" control.
- Change the setting on the "Phase" switch.

If you are hearing midrange frequencies (such as voices) through the subwoofer, check the following:

- When using the THX mode, make sure the subwoofer crossover is activated on your processor/receiver.
- When using the "Line Level" or "High Level Inputs," adjust the "Crossover Frequency" to a lower frequency.

Specifications

Amplifier Power

200 watts

Drivers

Dual 12" with polymer-laminated cones

Inputs

THX and normal line level, high level

Outputs

High level

Crossover Frequency –

Normal and High Level Inputs

50Hz – 120Hz (continuously adjustable)

Frequency Response (Determined by crossover setting)

25Hz – crossover point

Dimensions (HxWxD)

21-3/4 x 21 x 21"

552 x 533 x 533mm

Weight

67 lbs/30.5 kg



Occasional refinements may be made to existing products without notice, but will always meet or exceed original specifications unless otherwise stated.



JBL Consumer Products
80 Crossways Park West, Woodbury, NY 11797
8500 Balboa Boulevard, Northridge, CA 91329
1-800-336-4JBL (4525) (USA only)

© 1996 JBL, Incorporated. JBL is a registered trademark of JBL, Incorporated.
Lucasfilm and THX are registered trademarks of Lucasfilm Ltd.
Printed in Canada 12/96 ♻️ Part No. HTPS3000M

H A Harman International Company